

KENWOOD

PORTABLE COMPACT DISC PLAYER

DPC-861 DPC-761

INSTRUCTION MANUAL

KENWOOD CORPORATION

Note:
This instruction manual is for common use with the two models above.

For your records

Record the serial number, found on the back of the unit, in the spaces designated on the warranty card, and in the space provided below. Refer to the model and serial numbers whenever you call upon your dealer for information or service on the product.

Model _____ Serial Number _____

Unpacking

Unpack the unit carefully and make sure that all accessories are put aside so they will not be lost.

Examine the unit for any possibility of shipping damage. If your unit is damaged or fails to operate, notify your dealer immediately. If your unit was shipped to you directly, notify the shipping company without delay. Only the consignee (the person or company receiving the unit) can file a claim against the carrier for shipping damage.

We recommend that you retain the original carton and packing materials for use should you transport or ship the unit in the future.

Before using the rechargeable battery pack

The rechargeable battery pack comes non-charged condition. Read "Battery powered operation" carefully and charge the battery before use.

COMPACT
disc
DIGITAL AUDIO

B60-2284-00 (SD)(K, P) (MC)
96/12 11 10 9 8 7 6 5 4 3 2 1 95/12 11 10 9 8 7 6 5 4

AI edit playback

AI edit playback plays all of the tracks on a disc within the set time period by fading out (reducing volume gradually at the end of) every track. (Fast forward and fast reverse operations are not possible.)

Preparation

- Enter the stop mode by pressing the ■ key while playback.
- The program mode and repeat mode should be deactivated.

1 Press the P.MODE key twice.

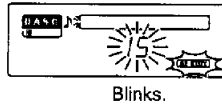

2 Select the time period available for playback.

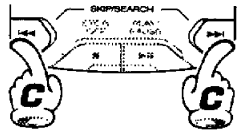

Each press of the key switches the time periods as follows.

- ➔ ① 15 (min.)
- ➔ ② 30
- ➔ ③ 45
- ➔ ④ 60

3 Start playback.

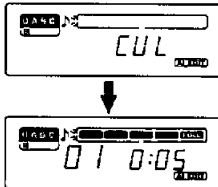
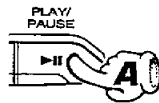

- AI edit playback may not be available if the disc contains a large number of tracks and the set period is too short for it.
- The AI edit mode can be canceled by pressing the ■ key in stop mode.

Various play

Pressing the REPEAT key in the stop mode allows you to enjoy various playback features.

Press the REPEAT key



Each press switches the repeat mode.

- ➔ ① **Canceled position**
Returns to the normal playback mode.
- ➔ ② **One-track repeat**
The track being played on the selected track will be played repeatedly.
- ➔ ③ **All-track repeat**
All tracks on the disc will be played repeatedly.
- ➔ ④ **Shuffle play**
All tracks on the disc will be played in a random order.
- ➔ ⑤ **Scan play**
A part of every track on the disc will be played for seconds. (Fast forward or fast reverse operation is not possible.)

- In case shuffle play or scan playback of the selected mode has completed.
- The REPEAT key is invalid during playback.

In case of difficulty

What seems to be a serious trouble may sometimes be due to a simple mistake. Before calling for service, check the items shown in the following table again. (If you request servicing due to the reasons shown in the table, the service may be charged in some cases.)

Symptom	Cause	Remedy
No operation occurs when operation keys are pressed.	<ul style="list-style-type: none"> The OPEN/HOLD switch is set to HOLD. The batteries are exhausted. The disc is placed upside down. Condensation has occurred inside the unit. The AC adapter or car battery adapter is disconnected. 	<ul style="list-style-type: none"> Set the switch to center. Replace both of the two dry cell batteries, or recharge the rechargeable batteries. Place the disc with the labeled side up. Leave the unit for about 1 hour before re-use. Connect it properly.
No sound is heard from the headphones.	<ul style="list-style-type: none"> The headphones are connected incompletely. The volume is set to the minimum position on the main unit. 	<ul style="list-style-type: none"> Insert the plug securely into the PHONES jack. Adjust the volume on the main unit.
Sound skips, or is interrupted.	<ul style="list-style-type: none"> The D.A.S.C. is set to "OFF". A strong vibration that exceeds the capacity of the D.A.S.C. has occurred. The disc is dirty. The lens is dirty. The headphone plug is dirty. The batteries are weak. 	<ul style="list-style-type: none"> Set the D.A.S.C. to "ON". Place the unit in a place not subject to vibration. Clean it. Clean it. Clean it. Replace or recharge the batteries.
Noise interferes.	<ul style="list-style-type: none"> The headphone plug is dirty. The batteries are weak. The headphones are connected incompletely. 	<ul style="list-style-type: none"> Clean it. Replace or recharge the batteries. Insert the plug securely into the PHONES jack.
Rechargeable batteries cannot be recharged.	<ul style="list-style-type: none"> Commercially-available rechargeable batteries are used. 	<ul style="list-style-type: none"> Use the exclusive rechargeable batteries (NB-100/NB-77/NB-88).

Notes

- This system uses a microcomputer so it may malfunction due to external noise or interference. In such a case, unplug the power cord and remove the batteries, then plug the power cord again and insert the batteries again.
- Erroneous operation may occur when the headphone plug is plugged or unplugged; but this is not a malfunction.



Dear Customer:

Selecting fine audio equipment such as the unit you've just purchased is only the start of your musical enjoyment. Now it's time to consider how you can maximize the fun and excitement your equipment offers. This manufacturer and the Electronic Industries Association's Consumer Electronics Group want you to get the most out of your equipment by playing it at a safe level. One that lets the sound come through loud and clear without annoying blaring or distortion — and, most importantly, without affecting your sensitive hearing.

Sound can be deceiving. Over time your hearing "comfort level" adapts to higher volumes of sound. So what sounds "normal" can actually be loud and harmful to your hearing. Guard against this by setting your equipment at a safe level BEFORE your hearing adapts.

To establish a safe level:

- Start your volume control at a low setting.
- Slowly increase the sound until you can hear it comfortably and clearly, and without distortion.

Once you have established a comfortable sound level:

- Set the dial and leave it there.

Taking a minute to do this now will help to prevent hearing damage or loss in the future. After all, we want you listening for a lifetime.

We Want You Listening For A Lifetime

Used wisely, your new sound equipment will provide a lifetime of fun and enjoyment. Since hearing damage from loud noise is often undetectable until it is too late, this manufacturer and the Electronic Industries Association's Consumer Electronics Group recommend you avoid prolonged exposure to excessive noise. This list of sound levels is included for your protection.

Decibel Level	Example
30	Quiet library, soft whispers
40	Living room, refrigerator, bedroom away from traffic
50	Light traffic, normal conversation, quiet office
60	Air conditioner at 20 feet, sewing machine
70	Vacuum cleaner, hair dryer, noisy restaurant
80	Average city traffic, garbage disposals, alarm clock at two feet.

THE FOLLOWING NOISES CAN BE DANGEROUS UNDER CONSTANT EXPOSURE

90	Subway, motorcycle, truck traffic, lawn mower
100	Garbage truck, chain saw, pneumatic drill
120	Rock band concert in front of speakers, thunderclap
140	Gunshot blast, jet plane
180	Rocket launching pad

Information courtesy of the Deafness Research Foundation.

tion indicator which lights
gging and blinks when the
attery power is low.
er information display
g indicator which
it is activated.
er repeat mode.

t. The card remote control unit

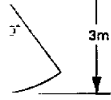
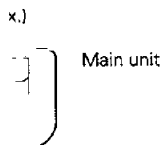

etween keys.
ncy lighting (inverter) fluorescent

WARNING: TO PREVENT FIRE OR ELECTRIC SHOCK, DO NOT EXPOSE

IMPORTANT SAFEGUARDS

Please read all of the safety and operating instructions before operating this unit. For best results, these safety and operating instructions should be retained for future reference.

- 1. Power sources** — The unit should be connected to a power supply only of the type described in the operating instructions or as marked on the appliance.
- 2. Power-cord protection** — Power-supply cords should be routed so that they are not likely to be walked on or pinched by items placed upon or against them, pay particular attention to cords at plugs, convenience receptacles, and the point where they exit from the unit.
- 3. Enclosure removal** — Never remove the enclosure. If the internal parts are touched accidentally, a serious electric shock might occur.
- 4. Drop** — Do not drop the unit or apply strong shock to it. (Damage due to dropping the unit is not covered by the warranty.)
- 5. Ventilation** — Avoid hindering the ventilation of the unit by covering it with a cloth, etc.
- 6. Abnormal smell** — If an abnormal smell or smoke is detected, immediately turn the power OFF and pull out the power cord. Contact your dealer or nearest service center.
- 7. Heat** — Avoid placing the unit under direct sunlight or near a source of heat such as heating equipment. Particularly, never leave it in an automobile or on the dashboard.
- 8. Temperature** — The unit may not function properly if used at extremely low, or freezing temperatures. The ideal ambient temperature is above +5°C (41°F).
- 9. Water and moisture** — The unit should not be used near water — for example, near a bathtub, washbowl, kitchen sink, laundry tub, in a wet basement, or near a swimming pool, etc.
- 10. Dust and moisture** — Avoid places where is dusty or where the humidity is high.
- 11. Vibrations** — Avoid placing the unit on an unstable place such as a shelf or in a place subject to vibrations.
- 12. Magnetic fields** — Keep the unit away from sources of magnetic fields such as TV sets, speaker systems, radios, motorized toys or magnetized objects.

selected tracks can be played in the desired order.

Programmed content

2.

to be changed.

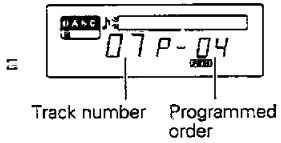

the programmed order containing
cd is displayed.

number.



To check the programmed contents

- 1 Enter the stop mode.
- 2 Press the P.MODE key.

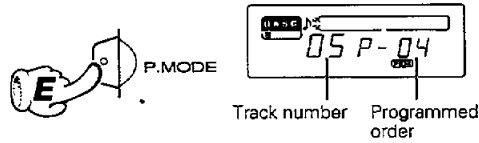

- Each press displays the next track number in the programmed order.

To clear the program

- 1 Enter the stop mode.
- 2 Press the  key.

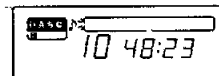
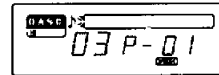
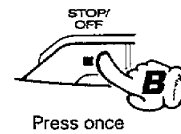

- Opening the lid cancels the program.

Battery powered operation

This unit can be powered
needed for car battery op-
If the unit is not to be used

Rechargeable battery operation

(Only the rechargeable battery packs specified by KENWOOD can be used.)

Be always sure to use the provided rechargeable battery pack or optional NB-100/NB-88 or NB-77. Never use other than specified battery packs. Recharging completes in about 3 (NB-100)/2 (NB-88/NB-77) hours.

- ① Insert rechargeable batteries paying attention to the ⊕ and ⊖ polarity.

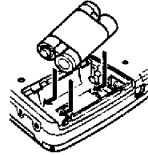

NB-100

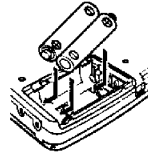

NB-88/NB-77

- Recharging is not possible during playback. Be sure to set the power OFF before starting recharging.
- The rechargeable batteries can be recharged and re-used for around 500 times. When the possible playback period decreases, purchase the optional NB-100/NB-88/NB-77 rechargeable batteries.
- Be sure to close the top cover of the unit before proceeding to recharging.

- ② Start recharging.

- (1) Set the power OFF.
(2) Plug in the AC adapter.



- (3) Wait for 5 seconds, then press the ■ key twice quickly.



- When using a rechargeable battery pack which is new or which has not been used for more than 2 months, the operating period may be shorter than normal. This is due to the properties of the battery and not a malfunction. After recharging, use the battery pack on the unit until it is exhausted. The original performance of the battery performance can be recovered by repeating this cycle a few times.

During recharging After recharging
Battery indicator lights. Extinguishes.

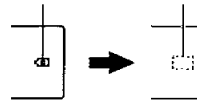

The unit returns to the power OFF status.

- ③ After recharging, unplug the AC adapter from this unit.

Battery duration indicator

The duration at which the battery indicator starts to blink is variable depending on the type of battery used. Refer to the table on the right.

Battery duration indicator

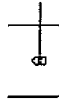

Battery Type	Blinking Timing
Rechargeable battery	When the battery is near exhausted
Dry cell batteries	When the batteries are exhausted

LD switch has been



performing an operation.

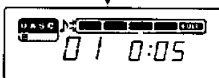

Track number Elapsed time of the track

Track begins.

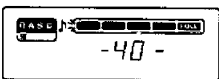

Volume display (0 to 62)

Use with remote controller, set the volume and adjust with the volume control.

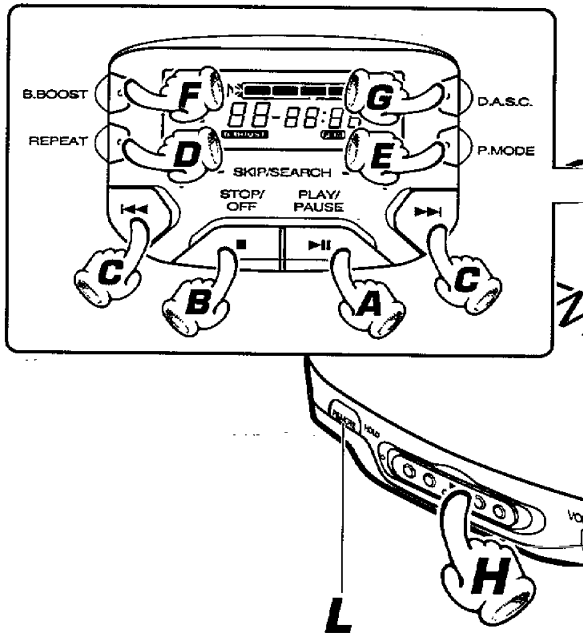

- A** ▶/|| key
Press to play a disc, pause playback or switch power ON.
- B** ■ key
Press to stop the disc, turn power OFF or recharge the unit.
- C** SKIP/SEARCH (◀◀, ▶▶) keys
Press to skip tracks or search disc in the forward or backward direction.
- D** REPEAT key
Press for using various playback features.
- E** P.MODE key
Use with program playback, AI edit playback, user repeat.
- F** B.BOOST key
Press to activate low-frequency compensation.

Connections

Ensure that the power of the all of the compon

Listening through speakers

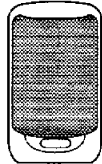

Speakers with built-in amplifier

Listening through car audio

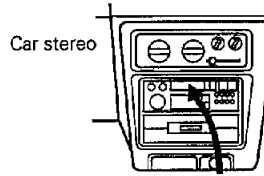

Car stereo

Car cassette adapter

Insert into cassette deck slot.

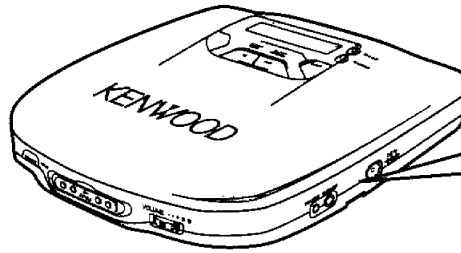
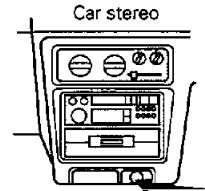

Illustration shows mor

Car battery powered operation

- When the unit is not used, unplug the car battery adapter. (Otherwise, the car battery may run out, with some car models.)
- The plug may not match the cigar lighter socket of some car models.
- If the unit cannot be operated with the car battery adapter connected, suspect the possibility of a blown fuse. The fuse can be replaced by turning the electrode on the tip of the adapter plug. When replacing the fuse, be sure to use a fuse with a rating of 1 A.



Connect to cigar lighter socket.

Maintenance

DPC-B61/761 [En]

Simple care

Care of lens

When the lens in the pick-up gets dirty, malfunctions including the impossibility of playback may occur. The lens should be cleaned using a commercially-available camera lens blower, etc. Do not touch the lens to prevent damaging the mechanism. Also do not use a lens cleaner or disc cleaner product.

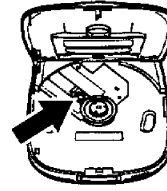

Care of main unit

When the unit gets dirty, clean with a soft, dry cloth. If the unit is stained seriously, a moistened cloth can be used. Do not use benzine or thinner for these will damage the unit.

Cleaning the plug

Wipe the headphone plug with a soft cloth to keep clean. A dirty plug may cause noise or malfunction.

Caution on disc used

Usable discs

This unit is capable of playing discs marked with **CD-DA**. Other discs cannot be played. 8 cm single CDs can be played as they are; do not use a commercially-available single CD adapter.

Handling

Hold compact discs so that you do not touch the playing surface. Do not attach paper or tape to either the playing side or the label side of compact discs.

Never play a cracked or warped disc.

During playback, the disc rotates at high speed in the player. Therefore, to avoid danger, never use a cracked or deformed disc or a disc repaired with tape or adhesive agent.

Cleaning

If fingerprints or foreign matter become attached to the disc; lightly wipe the disc with a soft cotton cloth (or similar) from the center of the disc outwards in a radial manner.



Storage

When a disc is not to be played for a long period of time, remove it from the CD player and store it in its case.

Precaution against condensation

Immediately after a room is heated or in a room with high humidity (or vapor), the unit may malfunction due to the condensation of dew or mist on the pick-up lens. In such a case, leave the unit for about an hour before trying to use it again.

The letter written on the hand in each illustration accompanying the text indicates the position of the pressed key on the unit.

Illustration shows model DPC-861

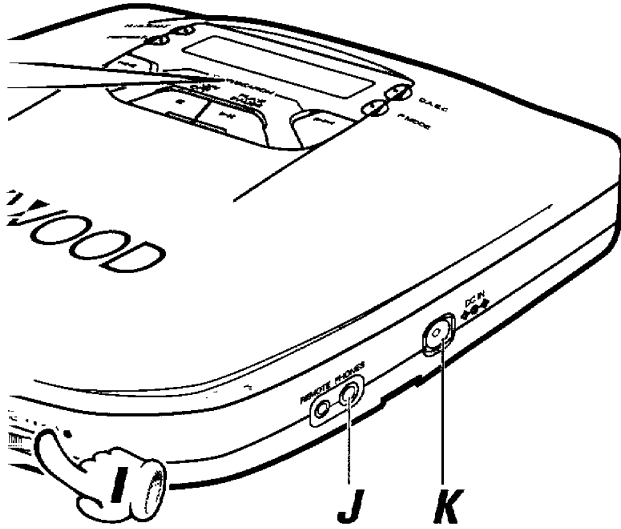

G D.A.S.C. key

Press to switch the Digital Anti-Shock Circuit which prevents sound skipping.

H OPEN/HOLD switch

Use to open the top lid and turn the hold function on/off.

I VOLUME control

Turn to adjust the listening level.

J PHONES (Headphones) jack

K DC IN jack

L Remote receptor

Only for models supplied with card remote control unit (see "Accessories").

To pause playback :

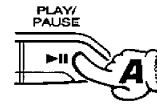

- When the ►/|| key is pressed rarely. Pressing the key again

To stop playback

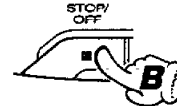

- The total number of tracks are displayed.

Compensation of lo:

The low frequencies sound boosted.



Each press switches this feature:

- ➔ **1 Bass Boost ON**
Low frequencies boosted.
- ➔ **2 Bass Boost OFF**
Normal tone reproduction
Indicator OFF

Temporarily

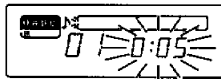

Blinks.

during playback, it pauses tempo- resumes playback.

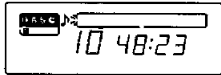

the total playing time of them will

frequencies

which is felt in headphone can be



alternately.

re



on.

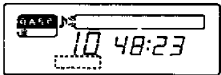

Goes off.

Track selection by track skip

To skip backward To skip forward

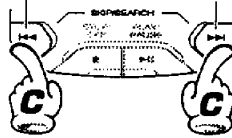

- The same number of tracks as the times the key is pressed can be skipped.
- When the left key is pressed once during playback, the played position returns to the beginning of the current track being played.

Fast forward, fast reverse

Fast reverse Fast forward

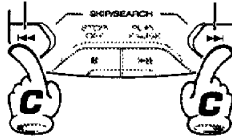

Hold the key pressed during playback.

- Playback resumes from the position where the key is released.
- If the key is released immediately after it has been pressed, the same operation as the track skip operation occurs.
- Fast forward and fast reverse operations are not possible during scan playback or AI edit playback.

To turn power OFF

After stopping playback, press the ■ key again.

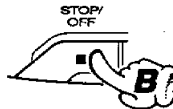

Auto power-Off function

If no operation key has been pressed for 3 minutes while the unit is in the stop mode, the power is turned OFF automatically to prevent battery power consumption.

Before applying power

Caution: Read this section carefully to ensure safe operation.

Units are designed for operation as follows.

U.S.A. and Canada **AC 120 V only**
Australia **AC 240 V only**
Europe and U.K. **AC 230 V only**
Other countries **AC 110-120 / 220 -240 V switchable**

For the U.S.A.

FCC WARNING:

This equipment may generate or use radio frequency energy. Changes or modifications to this equipment may cause harmful interference unless the modifications are expressly approved in the instruction manual. The user could lose the authority to operate this equipment if an unauthorized change or modification is made.

NOTE:

This equipment has been tested and found to comply with the limits for a CLASS B digital device, pursuant to Part 15 of the FCC Rules. These limits are designed to provide reasonable protection against harmful interference in a residential installation. This equipment may cause harmful interference to radio communications, if it is not installed and used in accordance with the instructions. However, there is no guarantee that interference will not occur in a particular installation. If this equipment does cause harmful interference to radio or television reception, which can be determined by turning the equipment off and on, the user is encouraged to try to correct the interference by one or more of the following measures:

- Reorient or relocate the receiving antenna.
- Increase the separation between the equipment and receiver.
- Connect the equipment into an outlet on a circuit different from that to which the receiver is connected.
- Consult the dealer or an experienced radio/TV technician for help.

For CANADA **DOC REGULATION**

"This digital apparatus does not exceed the CLASS B limits for radio noise emissions from digital apparatus as set out in the radio interference regulations of the Canadian Department of Communications."

The marking of products using lasers (Except for some areas).



This label is attached to the bottom panel and says that the component uses laser beams that have been classified as Class 1. It means that the unit is utilizing laser beams that are of a weaker class. There is no danger of hazardous radiation outside the unit.

is off before connecting the cords.

DPC-861/761 (En)

sound is not produced, change the tape playing direction of the car stereo.
sound is not produced if the car stereo is set to play tape side B.)
The sound reproduction may not be possible with some car stereo models.

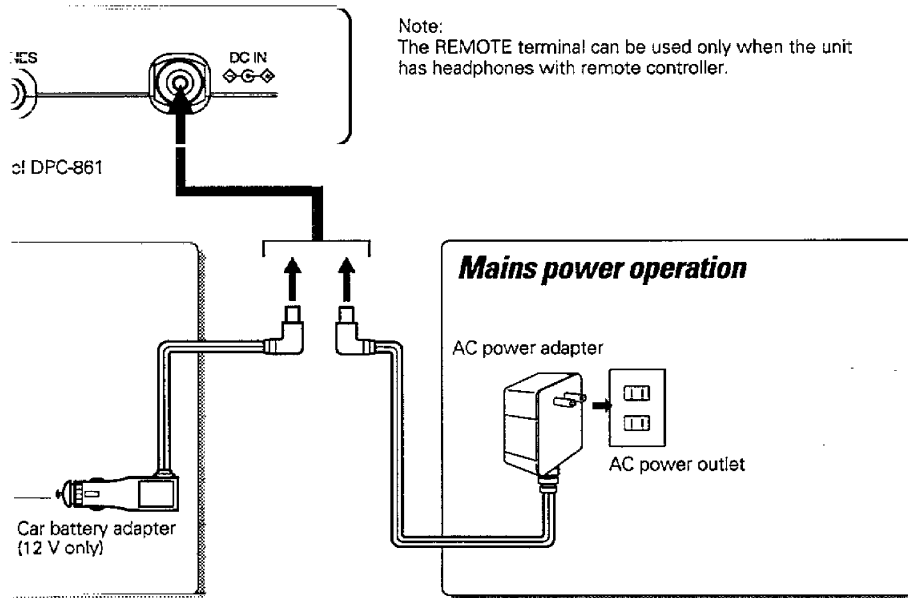

Playback from the first track

1 Connect headphones.

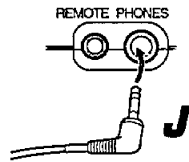

- Accepts the supplied headphones, or other optional headphones with a mini plug.
- The REMOTE terminal can be used only when the unit has headphones with remote controller.

2 Open the top cover.



3 Place a disc.

Place with labeled side up.

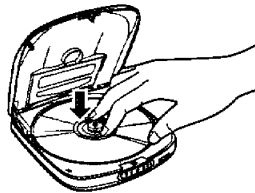

- Secure the disc by pushing a position near the center hole until it clicks.

4 Close the top cover.

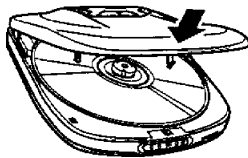

- Press down on the central front portion of the lid until it clicks shut.

5 Make sure the Hi is released.



- Release the HOLD switch when

6 Start playback.

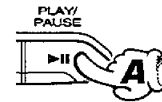

- The power comes ON and play:

7 Adjust the volume.

To decrease volume To increase volume

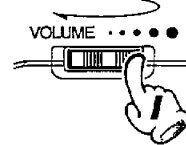

- When listening through headphones, volume of the player to around 40 of the remote controller.

from three kinds of power supplies: batteries, mains power or car battery. (The car battery adapter is not used.) When using batteries, use alkaline batteries or rechargeable batteries. For a long period (for more than one week), remove the batteries out of the unit.

Alkaline battery operation

- 1 Open the cover.

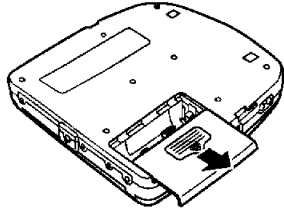

- 2 Insert two LR6 alkaline batteries paying attention to the \oplus and \ominus polarity.

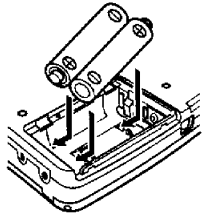

- Use commercially-available LR6 alkaline dry cell batteries.
- Always replace both batteries at a time.

- 3 Close the cover.

Treatment

In a while, the power will be turned off automatically. Then recharge the battery pack.

Playback is possible while the indicator is blinking.

Programming tracks in desired order

Preparations

- Enter the stop mode by pressing the **■** key while playback.

1 Press the P.MODE key.

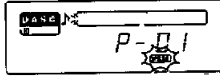

Lights.

2 Select the desired track numbers in the order you want to play them.

1 Select a track...

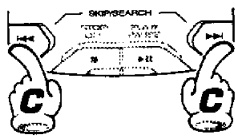

Programmed order



Track number blinks during selection.

2 And enter it.

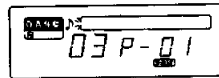

- Select other tracks in the desired order by repeating 1 and 2 above.
- Up to 20 tracks can be programmed at a time.

3 Start playback.

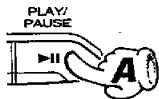

To change a program

1 Enter the stop mode

2 Display the content



- Press the key repeatedly until the track number to be changed is displayed.

3 Change the track

(1) Select a track...

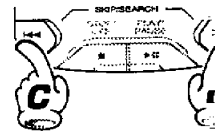

(2) And enter it.



THIS APPLIANCE TO RAIN OR MOISTURE.

ults, follow all warnings placed on the unit and adhere to the operating and use instructions.

- 13. Cleaning** — Do not use volatile solvents such as alcohol, paint thinner, gasoline, or benzene, etc. to clean the cabinet. Use a clean dry cloth.
- 14. Nonuse periods** — The power cord of the unit should be unplugged from the outlet when left unused for a long period of time.
- 15. Damage requiring service** — The unit should be serviced by qualified service personnel when:
- A.** The power-supply cord or the plug has been damaged; or
 - B.** Objects have fallen, or liquid has been spilled into the unit; or
 - C.** The unit has been exposed to rain; or
 - D.** The unit does not appear to operate normally or exhibits a marked change in performance; or
 - E.** The unit has been dropped, or the enclosure damaged.
- 16. Servicing** — The user should not attempt to service the unit beyond that described in the operating instructions. All other servicing should be referred to qualified service personnel.
- 17. CAUTION** — TO PREVENT ELECTRIC SHOCK DO NOT USE THE AC PLUG WITH AN EXTENSION CORD, RECEPTACLE OR OTHER OUTLET UNLESS THE BLADES CAN BE FULLY INSERTED TO PREVENT BLADE EXPOSURE.

Notes on using through car stereo

- In case of abnormality such as smoke production, immediately unplug the car battery adapter from the cigar lighter socket.
- Do not leave the products or batteries in the car, particularly above the dashboard, for this may lead to malfunction or damage due to solar heat.
- If the unit is connected to a car stereo using an audio cord, noise may sometimes interfere.

In case of abnormality, immediately press the open key to turn the power OFF, and unplug the AC adapter from the power outlet. Then please contact your nearest KENWOOD service center.

Controls and indicators

Display

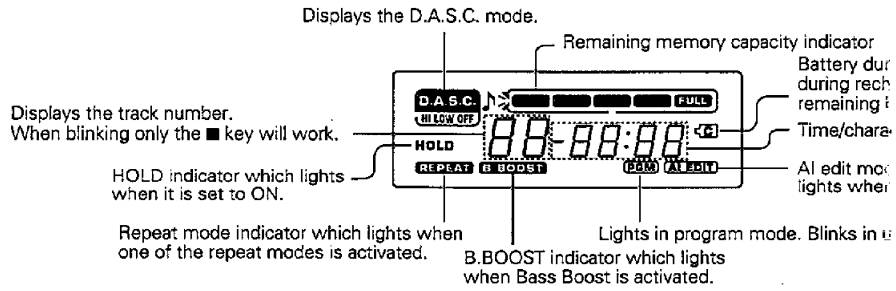

Card remote control unit

Only the type supplied can be used (see "Accessories").

When the card remote control unit is used, connect the AC adapter or car battery adapter to the main unit. The main unit cannot be used if the main unit is powered from batteries.

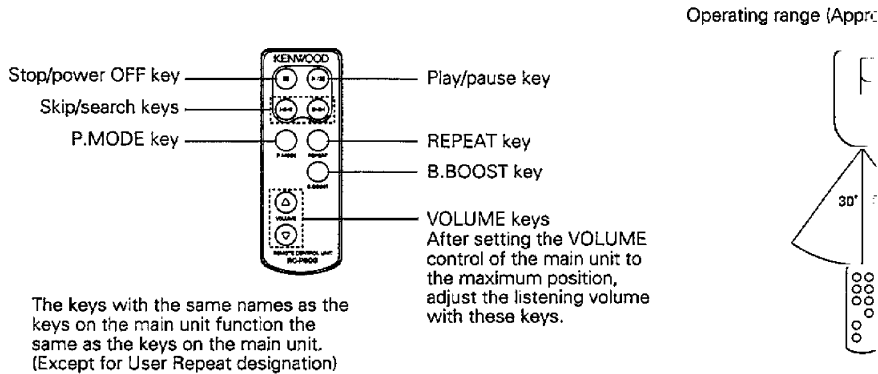

- When pressing several operation keys on the remote control unit, leave an interval of more than 1 second between each key press.
- Erroneous operation may occur when the main unit is illuminated by direct sunlight or the light of a high-frequency lamp. In such a case, change the unit position to prevent erroneous operation.
- For battery replacement, use a commercially-available lithium battery (CR2025).

For rechargeable battery: Type NB-88, NB-77



ATTENTION

Nickel-Cadmium battery must be recycled or disposed of properly.
State laws may vary regarding the handling and disposal of Nickel-Cadmium batteries.
Please contact your Authorized KENWOOD Dealer for more information.

For rechargeable battery: Type NB-100

WARNING

- Use specified charger only.
- Do not disassemble or mutilate, may cause burns.
- Do not incinerate or heat, may cause burns, burst or release toxic materials.
- Do not short circuit, may cause burns.
- Keep away from children.

For the U.S.A.

CAUTION:

Use of controls or adjustments or performance of procedures other than those specified herein may result in hazardous radiation exposure.

In compliance with Federal Regulations, following are reproductions of labels on, or inside the product relating to laser product safety.

KENWOOD CORPORATION
2967-3, ISHIKAWA-CHO,
HACHIOJI-SHI,
TOKYO, JAPAN

KENWOOD CORP. CERTIFIES THIS EQUIPMENT
CONFORMS TO DHHS REGULATIONS NO. 21
CFR 1040.10, CHAPTER I, SUBCHAPTER J.

Location: Bottom Panel

HOLD switch

The operation keys of the main unit except for the OPEN key and volume control are defeated. This position prevents undesired operation when the unit is put in a bag, etc.



Set to the left side.



- Be sure to release the switch (set to the center position) before performing any operations. Operations cannot be performed if it is in the HOLD position.

Sound skip guard function (D.A.S.C.)

* D.A.S.C. (Digital Anti Shock Circuit)

It prevents skipping by storing the CD's digital data in memory, and then playing back from the memory.

Mechanism of D.A.S.C.

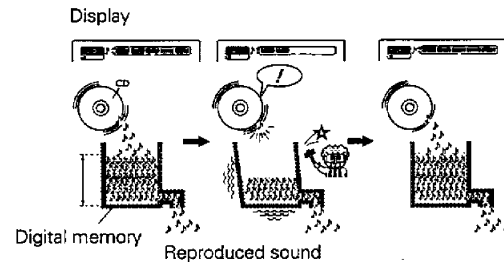

- In case of vibration above a certain degree, the memory data may be exhausted and the guard from sound skip may become temporarily ineffective.

Setting the D.A.S.C.



The reproduced sound is interrupted during switching.

Each press changes between the following.

- 1 **D.A.S.C. HI**
Memorizes about 11 seconds of digital data.
- 2 **D.A.S.C. LOW**
Memorizes about 5 seconds of digital data. Provides playback of higher sound quality than D.A.S.C. HI.
- 3 **D.A.S.C. OFF (cancel)**
We recommend turning off the skip guard to extend battery life when listening in a place with no vibrations.



back features

play or stop mode allows you to

7.



modes as follows.

ay



or
be



ill

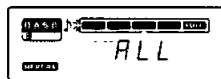

all
ks
m

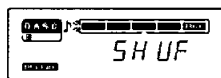

ie
0
st
ot

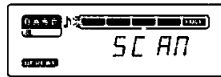

ay is selected during playback, the

ing AI edit playback.

Using User Repeat

If you designate the point you want to start listening from beforehand, you can return and start playback from that point while playing a different section. This is convenient when you want to listen starting from the same section repeatedly.

1 Designating the start position.

1 Start playing a CD.

- Be sure to cancel the program, AI edit, and repeat modes.

2 Hold down the P.MODE key for 2 seconds or longer at the point you want to designate.



Hold down for 2 seconds or more.

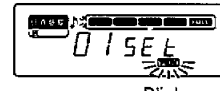

Blinks.

- If you want to change the start position, start over from step 2.
- Stopping playback cancels the designation.
- Selecting repeat mode cancels the designation.

2 Returning to the start position.

While continuing playback from step 1, press the P.MODE key when you want to return to the designated position.



Press once

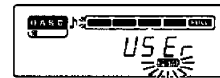

Blinks.

- Playback starts from the designated position.
- Stopping playback cancels the designation.
- Selecting repeat mode cancels the designation.

Specifications

Format

System Compact disc digital audio system
 Laser Semiconductor laser

Audio

Frequency response 20 Hz ~ 20 kHz, ± 3 dB
 PHONES output level/impedance max. 900 mV/22 k Ω
 (Headphone output: 16 Ω , 1 kHz 10 mW + 10 mW)

Power supply

External DC supply DC 12 V
 Rechargeable battery DC 2.4 V
 Commercially-available alkaline batteries (LR6, AA) $\times 2$ DC 3 V

Battery life (continuous repeat playback)

(Figures inside parentheses are the values when D.A.S.C. is ON.)

Commercially-available alkaline batteries (LR6, AA) $\times 2$ Approx. 9 (5.5) hours
 Rechargeable battery (NB-88) Approx. 4 (3.5) hours

Dimensions (W \times H \times D) 130 mm \times 32 mm \times 137 mm
 (5 - 1/8" \times 1 - 1/4" \times 5 - 3/8")

Weight (net) 275 g (9.7 oz.)

Note:

KENWOOD follows a policy of continuous advancements in development. For this reason specifications may be changed without notice.

Accessories	DPC-861	DPC-761
Headphones	1	1
Rechargeable battery	NB-88 $\times 2$	NB-88 $\times 2$
AC adaptor	1	1
Car cassette adaptor	1	1
Car battery adaptor	1	1
Card remote control unit	1	—

The standard accessories vary depending on the model of the unit.

The accessories which are not equipped as standard are optionally available. For details, please consult your dealer.